

## ORBIWELD 12 Microweldhead For Tubes from 3 - 12,7 mm

The ideal solution for Semiconductor Industries and wherever you have extreme low clearances. Matches all types of Microfittings!

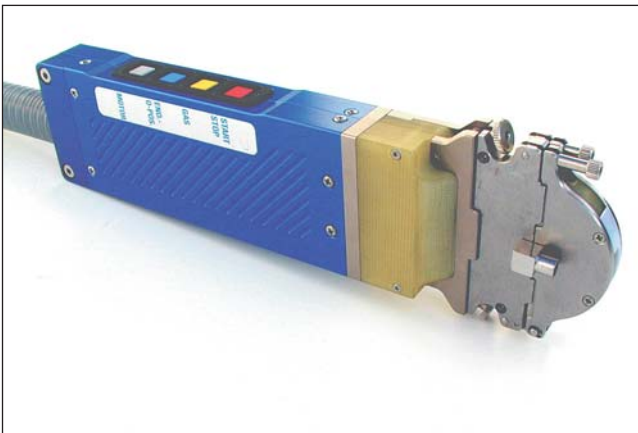

With thin cartridge, especially for Microfittings



Wide and thin cartridge

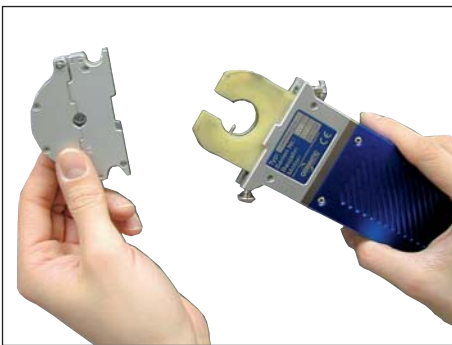

The removable cartridge system allows precise alignment of the joining parts, even under extremely narrow conditions

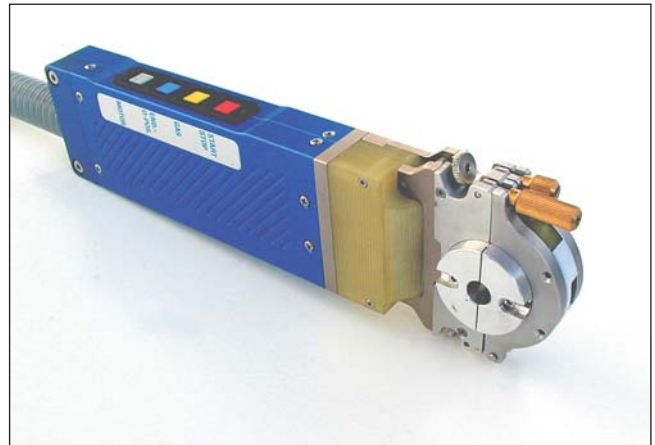

With wide cartridge and changeable collets

The **ORBIMATIC ORBIWELD 12** Microweldhead, with its extremely compact design and the various cartridges, offers a unique flexibility and through an integral water-cooled body design an unusual high duty cycle for a weld head in that size concept.

Together with the **ORBIMAT C** range of Orbital Power Sources you will get a High-Precision welding system with multiple choices but still easy operation.

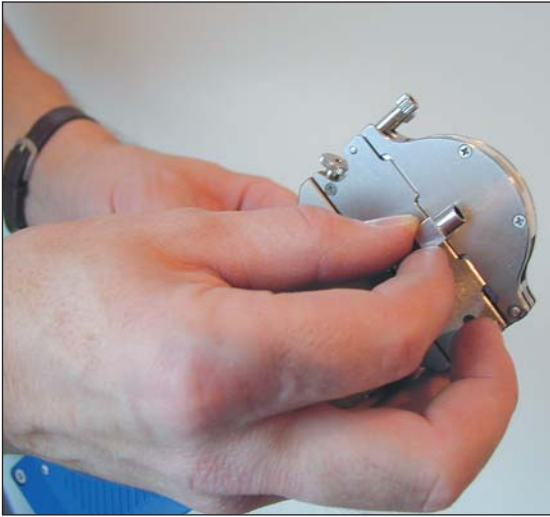

The extremely small design allows even the joint of Microfitting to Microfitting.

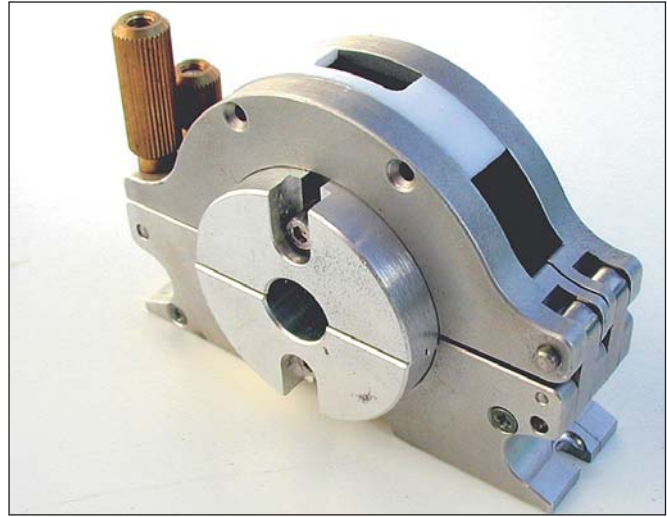

Wide Cartridge with changeable collets for standard applications except for Microfittings.

For each tube size one specific Cartridge is required.

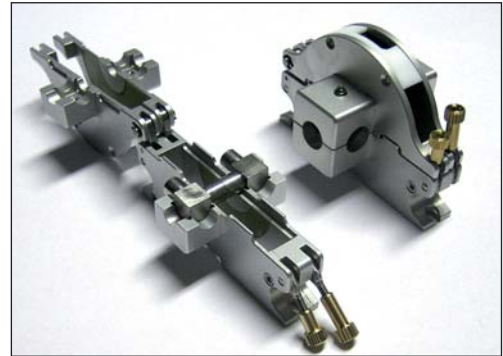

### Dimensions ORBIWELD 12 with

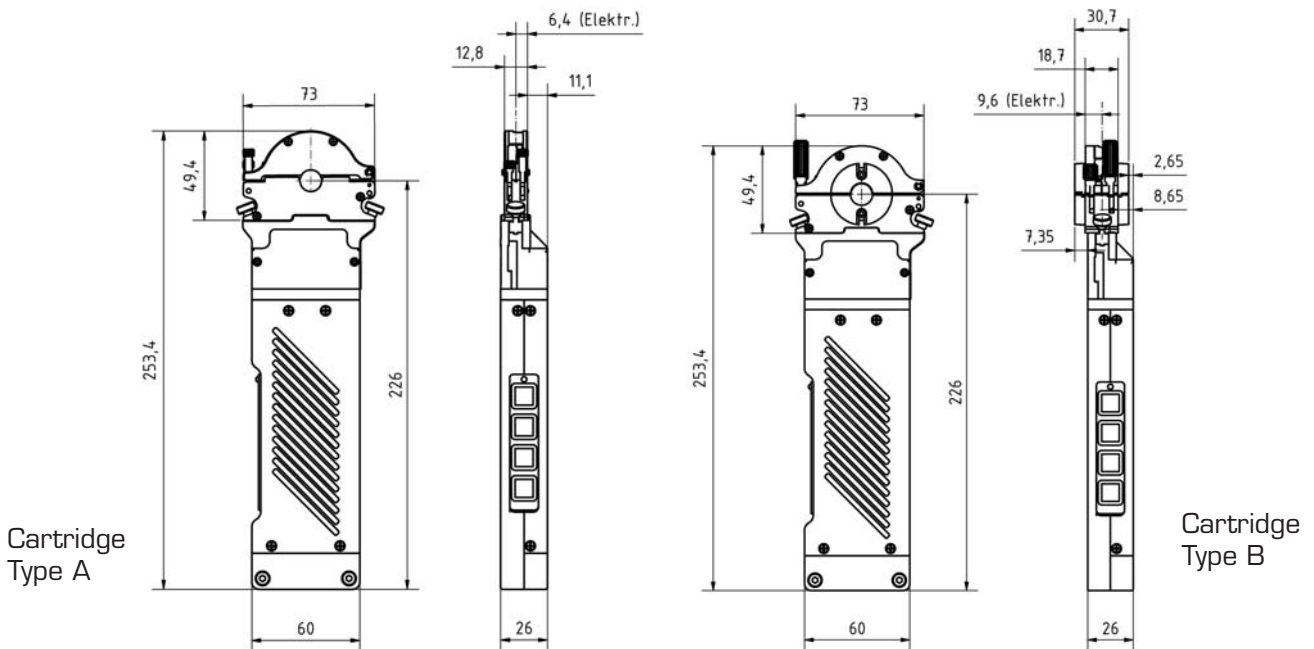

Specification subject to change without notice



**ORBIMATIC (UK) Limited**  
 7 The Manor Grove Centre  
 Vicarage Farm Road  
 Peterborough PE15UH  
 Phone +44 (0) 1733 555285  
 Fax +44 (0) 1733 847711  
 E-mail: info@orbimatic.co.uk  
 Internet: www.orbimatic.co.uk

**ORBIMATIC GmbH**  
 Flösser Weg 17  
 D-35418 Buseck / Germany  
 Telefon (0 64 08) 90 26-0  
 Telefax (0 64 08) 90 26-50  
 E-mail: Orbimatic@t-online.de  
 Internet: www.orbimatic.com